

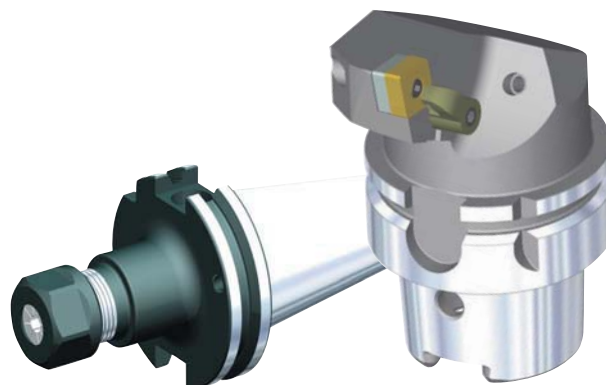

Utensili con codolo ERICKSON™

IntroduzioneB2
ProduttivitàB3
Guide alle selezioniB4–B19
TornituraB4–B5
Tornitura/fresaturaB5
FresaturaB6–B12
ForaturaB12–B16
MaschiaturaB16–B18
BarenaturaB18–B19
Utensili con codolo HSKC1–C165
Utensili con codolo BTKVD1–D37
Utensili con codolo CVKVD38–D67
Utensili con codolo BTE1–E95
Utensili con codolo CVF1–F83
Utensili con codolo DVG1–G77
Utensili con codolo QCH1–H22
Utensili con codolo R8H24–H27
Utensili con codolo drittoI1–I27



La forza di lavoro di Kennametal

Sistemi di utensili

Kennametal è orgogliosa di offrire prodotti ERICKSON™ di eccellente qualità, in modo da garantire al cliente l'acquisto dei migliori prodotti del settore. L'intero portafoglio, comprensivo di prodotti con cono a forte inclinazione, HSK, pinze, boccole e prodotti accessori garantisce una produttività elevata, maggiore precisione e flessibilità nelle applicazioni.

Progettate per una doppia possibilità di cambio degli utensili, automatico e manuale, le interfacce Erickson sono perfette per la maggior parte delle macchine utensili e presentano una costruzione compatta e rigida garantita per utilizzare coppie elevate e assicurare volumi ottimali di truciolo asportato.

Gli operatori del settore si affidano a ERICKSON da oltre 60 anni. La gamma di utensili ERICKSON, fra le più vaste del settore, può essere utilizzata in tutti i tipi di lavorazione, fra cui le applicazioni a bassa velocità, la fresatura di sgrossatura e le lavorazioni a velocità superiori ai 20.000 giri/min.

Tecnologia di calettamento a caldo Kennametal

Il calettamento a caldo non è nuovo nell'industria delle macchine utensili, ma solo recentemente è stato applicato ai sistemi portautensili a cambio rapido. Ciò che permette il funzionamento del calettamento a caldo è il fatto di avere portautensili con foro interno leggermente più piccolo rispetto all'estremità di attacco del codolo.

Quando il portautensili è riscaldato, il foro si espande e il codolo si innesta al suo interno. Il portautensili si restringe per effetto del raffreddamento, serrando insieme i due pezzi. Questo genera una pressione uniformemente distribuita con vibrazioni minime tra il portautensili e il codolo, rendendo il gruppo simile a un utensile monoblocco.



Vantaggi degli utensili a calettamento a caldo

- Pressione distribuita uniformemente a 360° per tutta la circonferenza dell'utensile da taglio.
- È possibile ottenere portautensili sottili e corti, grazie alla mancanza di parti mobili.
- Il bloccaggio completamente simmetrico permette il miglior equilibrio possibile per le lavorazioni ad alta velocità.
- Forza di bloccaggio maggiore rispetto a quella di altri mandrini idraulici o pinze.
- Ripetibile per migliaia di volte.
- In grado di lavorare a velocità e avanzamenti più elevati.
- Si adatta a diversi tipi di codolo.
- Maggiore produttività.



Mandrini idraulici Kennametal

I mandrini idraulici Kennametal consentono risultati ottimali per il bloccaggio di codoli completamente cilindrici, come ad esempio per punte in metallo duro e frese a candela. Ruotando un pistone viene data pressione al fluido idraulico, che espande una membrana a parete sottile per la lunghezza del foro di bloccaggio. Questo genera una presa solida che riduce le vibrazioni ed elimina le microfessure su utensili da taglio.

Tutti i mandrini possono utilizzare pinze di riduzione per garantire la massima versatilità. I mandrini idraulici non richiedono praticamente alcuna manutenzione, a parte la pulizia ordinaria del foro con rimozione del grasso.



Slim Line

Mandrini idraulici di forma sottile per qualsiasi uso con massima precisione.



Standard/HP Line

Mandrini prebilanciati con una vite esterna per la regolazione radiale. Questo elimina la necessità di rimuovere gli utensili da taglio per effettuare regolazioni di precisione.



Trend Line

Simile ai mandrini Standard Line ma con regolazione radiale 3/8" rispetto alla lunghezza dell'utensile da taglio mediante l'utilizzo di una vite di regolazione assiale attraverso il foro del mandrino.



Basic Line

Simile a Trend Line ma con diametri del corpo maggiori che implicano una stabilità più alta e l'aumento della coppia.

Mandrini portapinza Kennametal

Pinze TG

Una pinza ad angolo singolo che ha una presa con un rapporto di circa 1:3 tra coppia di bloccaggio e coppia di presa, senza vite di arresto.

Pinze ER

Una pinza standard internazionale che può essere utilizzata per lavorazioni quali fresatura, alesatura, maschiatura e foratura.

Adattatori per frese a manicotto Kennametal

Tutti gli adattatori sono disponibili standard con un nuovo passaggio refrigerante per migliorare la capacità del tagliente. Questo migliora la durata dell'utensile e il controllo del truciolo. Gli adattatori per frese a manicotto sono disponibili con lunghezze estese e una serie di diametri di montaggio di piccole dimensioni.

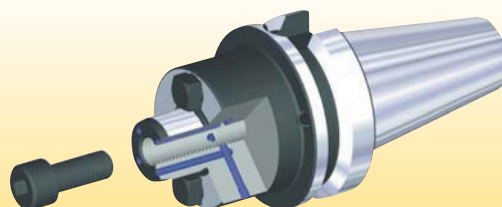

Opzioni portautensili ERICKSON

HSK40A • HSK50A • HSK63T
HSK63A • HSK80A • HSK100A

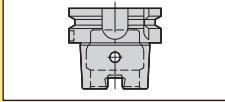

HSK32C • HSK40C
HSK50C • HSK63C

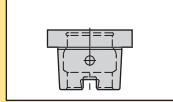

HSK40E • HSK50E

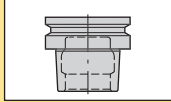

HSK63FP • HSK80FP

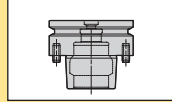

BTKV40 • BTKV50

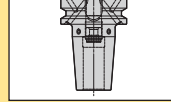

CVKV40 • CVKV50

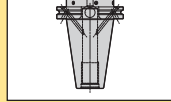

tornitura esterna

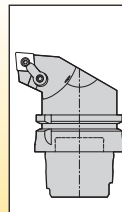
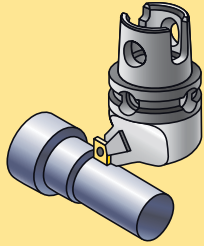

Bloccaggio M

HSK63T

Pagina: C34

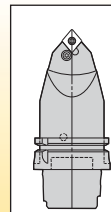

**Bloccaggio P
(asse centrale)**

HSK63T

Pagine: C35–C36

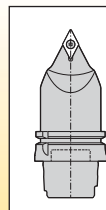

**Bloccaggio S
(asse centrale)**

HSK63T

Pagina: C37

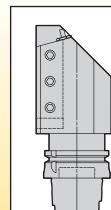

**Adattatori per
codolo quadro
STA ed ETA**

HSK63T

Pagine: C33–C34

Troncatura esterna

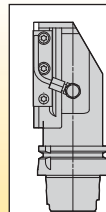
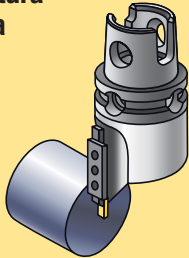

A2™

HSK63T

Pagina: C39

Scanalatura esterna

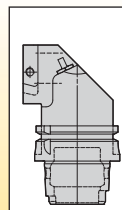
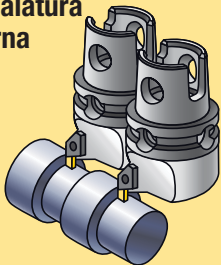



**A3™/A4™
modulare**

HSK63T

Pagina: C38

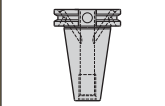
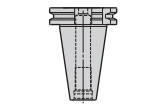
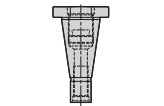
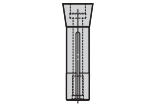
Indica "non disponibile".

BT30 • BT40 • BT50	CV40 • CV50	DV40 • DV50	QC30 • QC40 • QC50	R8	SS	Opzioni portautensili ERICKSON
						

Filettatura esterna

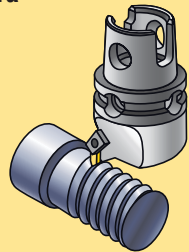

Filettatura LT

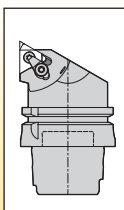

HSK63T Pagina: C40

Adattatori per tornitura

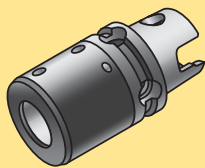

Adattatori per baren

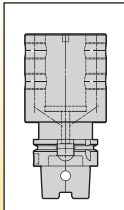

HSK63T Pagine: C41–C42

Riduzioni per baren

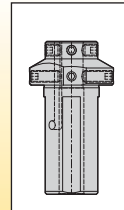

Pagina: A570

Asse centrale esterno

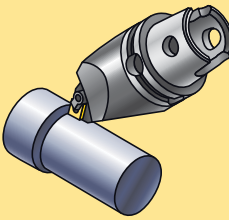

Bloccaggio P

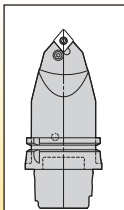

HSK63T Pagine: C35–C36

Bloccaggio S

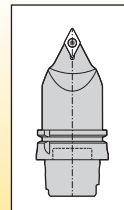

HSK63T Pagina: C37

 Indica "non disponibile".

Opzioni portautensili ERICKSON

HSK40A • HSK50A • HSK63T
HSK63A • HSK80A • HSK100A

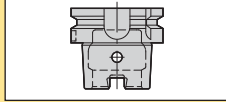

HSK32C • HSK40C
HSK50C • HSK63C

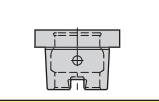

HSK40E • HSK50E

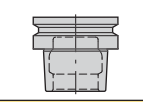

HSK63FP • HSK80FP

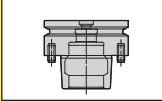

BTKV40 • BTKV50

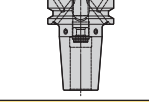

CVKV40 • CVKV50

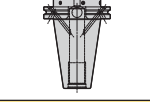

Fresatura

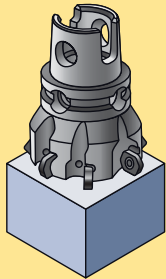

Calettamento a caldo

	HSK40A	Pagine: C8–C11	HSK40E	Pagine: C147–C149	BT50	Pagine: E66–E69
	HSK50A	Pagine: C24–C25	HSK50E	Pagina: C155	CV40	Pagine: F6–F9
	HSK63T		HSK63F	Pagina: C159	CV50	Pagine: F44–F47
	HSK63A	Pagine: C46–C50	HSK80F	Pagina: C163	DV40	Pagine: G6–G9
	HSK80A	Pagine: C76–C79	BTKV40	Pagine: D4–D7	DV50	Pagine: G46–G49
	HSK100A	Pagine: C96–C99	BTKV50	Pagine: D22–D25	QC30	
	HSK32C		CVKV40	Pagine: D40–D43	QC40	
	HSK40C		CVKV50	Pagine: D54–D57	QC50	
	HSK50C		BT30	Pagine: E24–E27	R8	
	HSK63C		BT40	Pagina: E4–E6	Codoli dritti	

Calettamento a caldo SAFE-LOCK

SAFE-LOCK™
by HAIMER

	HSK40A		HSK40E		BT50	Pagina: E64
	HSK50A		HSK50E		CV40	Pagina: F5
	HSK63T		HSK63F		CV50	Pagine: F42–F43
	HSK63A	Pagina: C45	HSK80F		DV40	Pagina: G5
	HSK80A		BTKV40		DV50	Pagina: G44
	HSK100A	Pagine: C94–C95	BTKV50		QC30	
	HSK32C		CVKV40		QC40	
	HSK40C		CVKV50		QC50	
	HSK50C		BT30		R8	
	HSK63C		BT40		Pagina: E23	

Mandrini a forte serraggio

	HSK40A		HSK40E		BT50	Pagina: E75
	HSK50A		HSK50E		CV40	Pagina: F17
	HSK63T		HSK63F		CV50	Pagina: F55
	HSK63A	Pagina: C56	HSK80F		DV40	Pagina: G15
	HSK80A		BTKV40		DV50	Pagina: G54
	HSK100A	Pagina: C104	BTKV50		QC30	
	HSK32C		CVKV40		QC40	
	HSK40C		CVKV50		QC50	
	HSK50C		BT30		R8	
	HSK63C		BT40		Pagina: E8	

Mandrini portapinzina TG

	HSK40A	Pagina: C16	HSK40E		BT50	Pagina: E76	
	HSK50A	Pagina: C27	HSK50E		CV40	Pagine: F18–F20	
	HSK63T		HSK63F		CV50	Pagine: F56–F60	
	HSK63A	Pagina: C57	HSK80F		DV40	Pagine: G16–G17	
	HSK80A	Pagina: C82	BTKV40		DV50	Pagine: G55–G56	
	HSK100A	Pagina: C105	BTKV50		QC30	Pagina: H4	
	HSK32C		CVKV40		Pagina: D26	QC40	Pagina: H11
	HSK40C		CVKV50		Pagina: D45	QC50	Pagina: H19
	HSK50C		BT30		Pagina: E9	R8	
	HSK63C		BT40		Pagina: E34	Codoli dritti	Pagine: I6–I7

Indica "non disponibile".

(continua)

BT30 • BT40 • BT50

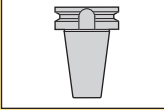

CV40 • CV50

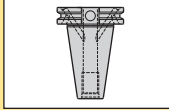

DV40 • DV50

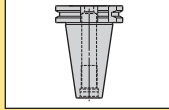

QC30 • QC40 • QC50

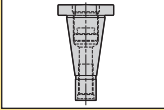

R8

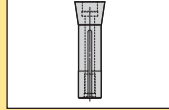

SS

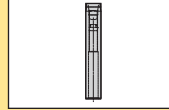
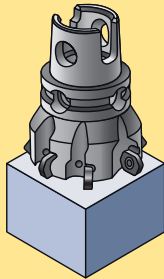
Opzioni portautensili ERICKSON
Fresatura (continua)

Mandrini idraulici

	HSK40A	Pagine: C12–C15	HSK40E	Pagina: C150	BT50	Pagine: E70–E74
	HSK50A	Pagina: C26	HSK50E	Pagina: C156	CV40	Pagine: F10–F16
	HSK63T		HSK63F		CV50	Pagine: F48–F54
	HSK63A	Pagine: C52–C55	HSK80F		DV40	Pagine: G10–G14
	HSK80A	Pagine: C80–C81	BTKV40		DV50	Pagine: G50–G53
	HSK100A	Pagine: C100–C103	BTKV50		QC30	
	HSK32C	Pagina: C124	CVKV40		QC40	
	HSK40C	Pagine: C128–C130	CVKV50		QC50	
	HSK50C	Pagine: C136–C137	BT30	R8		
	HSK63C	Pagine: C141–C142	BT40	Pagina: E7	Codoli dritti	
				Pagine: E28–E32		

Mandrini portapinza ER

	HSK40A	Pagina: C17	HSK40E	Pagina: C151	BT50	Pagine: E77–E79
	HSK50A	Pagine: C28–C29	HSK50E		CV40	Pagine: F21–F23
	HSK63T		HSK63F	Pagina: C160	CV50	Pagine: F61–F63
	HSK63A	Pagine: C58–C59	HSK80F	Pagina: C164	DV40	Pagine: G18–G21
	HSK80A	Pagine: C83–C84	BTKV40	Pagine: D10–D11	DV50	Pagine: G57–G59
	HSK100A	Pagine: C106–C107	BTKV50	Pagine: D28–D29	QC30	
	HSK32C	Pagina: C125	CVKV40	Pagine: D46–D47	QC40	
	HSK40C	Pagina: C131	CVKV50	Pagine: D60–D61	QC50	
	HSK50C	Pagina: C138	BT30	Pagine: E10–E11	R8	
	HSK63C	Pagina: C143	BT40	Pagine: E35–E37	Codoli dritti	Pagine: I8–I11

Mandrini portapinza DA

	HSK40A		HSK40E		BT50	Pagina: E80
	HSK50A		HSK50E		CV40	Pagina: F24
	HSK63T		HSK63F		CV50	Pagina: F64
	HSK63A		HSK80F		DV40	Pagine: G22–G25
	HSK80A		BTKV40		DV50	Pagine: G60–G61
	HSK100A		BTKV50		QC30	Pagina: H5
	HSK32C		CVKV40		QC40	Pagina: H12
	HSK40C		CVKV50		QC50	
	HSK50C		BT30		R8	Pagina: H26
	HSK63C		BT40		Codoli dritti	Pagine: I12–I22
						Pagine: E12–E13
						Pagine: E38–E39

Adattatori Whistle Notch™

	HSK40A	Pagina: C18	HSK40E		BT50	Pagine: E81–E82	
	HSK50A		HSK50E		CV40	Pagine: F26–F27	
	HSK63T		HSK63F		CV50	Pagine: F66–F68	
	HSK63A	Pagine: C60–C61	HSK80F		DV40	Pagine: G27–G28	
	HSK80A	Pagina: C85	BTKV40		DV50	Pagine: G63–G64	
	HSK100A	Pagine: C108–C109	BTKV50		QC30		
	HSK32C		CVKV40		QC40		
	HSK40C	Pagina: C132	CVKV50		QC50		
	HSK50C	Pagina: C139	BT30		R8		
	HSK63C	Pagina: C144	BT40		Pagina: E41–E42	Codoli dritti	
					Pagina: E14		

Indica "non disponibile".

(continua)

Opzioni portautensili ERICKSON

HSK40A • HSK50A • HSK63T
HSK63A • HSK80A • HSK100A

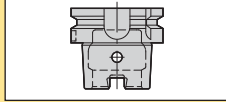

HSK32C • HSK40C
HSK50C • HSK63C

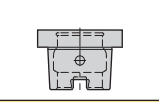

HSK40E • HSK50E

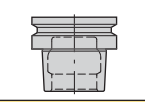

HSK63FP • HSK80FP

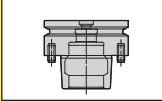

BTKV40 • BTKV50

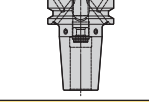

CVKV40 • CVKV50

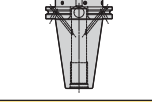

Fresatura (continua)

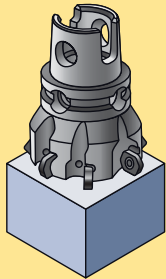

Adattatori per frese a candela

	HSK40A	Pagina: C19	HSK40E		BT50	Pagina: E83
	HSK50A		HSK50E		CV40	Pagine: F28–F29
	HSK63T		HSK63F		CV50	Pagine: F70–F72
	HSK63A	Pagina: C62	HSK80F		DV40	Pagine: G29–G30
	HSK80A	Pagina: C86	BTKV40		DV50	Pagine: G65–G66
	HSK100A	Pagina: C110	BTKV50		QC30	Pagina: H6
	HSK32C		CVKV40		QC40	Pagina: H14
	HSK40C		CVKV50		QC50	Pagina: H20
	HSK50C		BT30		R8	Pagina: H27
	HSK63C		BT40		Pagine: E43–E45	Codoli dritti

Adattatori per frese a manicotto

	HSK40A	Pagina: C20	HSK40E	Pagina: C152	BT50	Pagine: E86–E88
	HSK50A	Pagina: C30	HSK50E		CV40	Pagina: F32
	HSK63T		HSK63F		CV50	Pagine: F76–F77
	HSK63A	Pagine: C65–C66	HSK80F		DV40	Pagine: G32–G33
	HSK80A	Pagine: C87–C88	BTKV40		DV50	Pagine: G68–G69
	HSK100A	Pagine: C114–C115	BTKV50		QC30	Pagina: H7
	HSK32C		CVKV40		QC40	Pagina: H15
	HSK40C		CVKV50		QC50	Pagina: H21
	HSK50C		BT30		R8	Pagina: H27
	HSK63C		BT40		Pagine: E50–E52	Codoli dritti

Adattatori per frese a manicotto antivibranti

	HSK40A		HSK40E		BT50	Pagine: E84–E85	
	HSK50A		HSK50E		CV40	Pagina: F31	
	HSK63T		HSK63F		CV50	Pagina: F75	
	HSK63A		Pagina: C64		HSK80F	DV40	Pagina: G31
	HSK80A				BTKV40	DV50	Pagina: G67
	HSK100A		Pagine: C112–C113		BTKV50	QC30	
	HSK32C				CVKV40	QC40	
	HSK40C				CVKV50	QC50	
	HSK50C				BT30	R8	
	HSK63C				BT40	Pagine: E48–E49	

Adattatori combinati per frese a manicotto

	HSK40A		HSK40E		BT50	Pagina: E89	
	HSK50A		HSK50E		CV40		
	HSK63T		HSK63F		CV50		
	HSK63A		Pagina: C67		HSK80F		DV40
	HSK80A		Pagina: C89		BTKV40	DV50	Pagina: G70
	HSK100A		Pagina: C116		BTKV50	QC30	
	HSK32C				CVKV40	QC40	
	HSK40C				CVKV50	QC50	
	HSK50C				BT30	R8	
	HSK63C				BT40	Pagina: E53	

Indica "non disponibile".

(continua)

BT30 • BT40 • BT50



CV40 • CV50

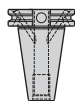

DV40 • DV50

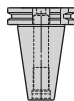

QC30 • QC40 • QC50

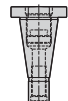

R8

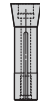

SS

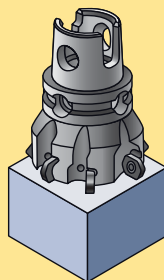
**Opzioni
portautensili
ERICKSON**
Fresatura (continua)

Adattatori per frese a scanalare

	HSK40A		HSK40E		BT50	Pagina: E90	
	HSK50A		HSK50E		CV40	Pagina: F33	
	HSK63T		HSK63F		CV50	Pagina: F77	
	HSK63A	Pagina: C68	HSK80F		DV40		
	HSK80A		BTKV40		DV50		
	HSK100A	Pagina: C117	BTKV50		QC30		
	HSK32C		CVKV40		QC40		
	HSK40C		CVKV50		QC50	Pagina: H22	
	HSK50C		BT30		R8		
	HSK63C		BT40		Pagina: E54	Codoli dritti	Pagina: I27

Adattatori screw-on

	HSK40A	Pagina: C21	HSK40E	Pagina: C153	BT50	Pagina: E90	
	HSK50A	Pagina: C31	HSK50E	Pagina: C157	CV40	Pagina: F34	
	HSK63T		HSK63F		CV50	Pagina: F78	
	HSK63A	Pagina: C69	HSK80F		DV40	Pagina: G35	
	HSK80A		BTKV40		DV50	Pagina: G71	
	HSK100A	Pagina: C117	BTKV50		QC30		
	HSK32C		CVKV40		QC40		
	HSK40C		CVKV50		QC50		
	HSK50C		BT30		Pagina: E18		R8
	HSK63C		BT40		Pagina: E55	Codoli dritti	Pagine: I23-I26

Indica "non disponibile".

Opzioni portautensili ERICKSON

HSK40A • HSK50A • HSK63T
HSK63A • HSK80A • HSK100A

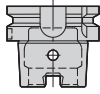

HSK32C • HSK40C
HSK50C • HSK63C



HSK40E • HSK50E



HSK63FP • HSK80FP



BTKV40 • BTKV50

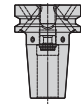

CVKV40 • CVKV50

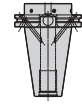

Pinze e riduzioni

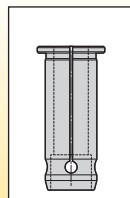
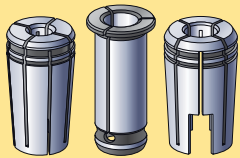

Riduzioni per forte serraggio

Pagine: J6–J9

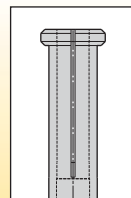

Riduzioni per idraulici

Pagine: J2–J5

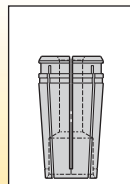

Pinze TG

Pagine: J14–J19, J22–J27, J30–J38, J42–J47

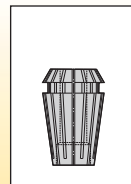

Pinze ER

Pagine: J54–J57

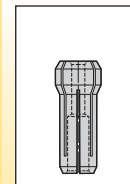

Pinze DA

Pagine: J65–J69

Riduzioni adattatori prolungha

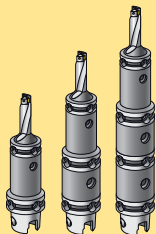

Modulare

	HSK40A		HSK40E		BT50	Pagina: E94
	HSK50A		HSK50E		CV40	Pagina: F38
	HSK63T		HSK63F		CV50	Pagina: F82
	HSK63A	HSK80F	DV40		Pagina: G39	
	HSK80A	BTKV40	DV50		Pagina: G75	
	HSK100A	BTKV50	QC30			
	HSK32C	CVKV40	QC40			
	HSK40C	CVKV50	QC50			
	HSK50C	BT30	R8			
	HSK63C	BT40	Codoli dritti			

HSK Modulare

	HSK40A		HSK40E		BT50	Pagina: E95
	HSK50A		HSK50E		CV40	Pagina: F39
	HSK63T		HSK63F		CV50	Pagina: F83
	HSK63A	HSK80F	DV40		Pagina: G40	
	HSK80A	BTKV40	DV50		Pagina: G76	
	HSK100A	BTKV50	QC30			
	HSK32C	CVKV40	QC40			
	HSK40C	CVKV50	QC50			
	HSK50C	BT30	R8			
	HSK63C	BT40	Codoli dritti			

Indica "non disponibile".

BT30 • BT40 • BT50



CV40 • CV50

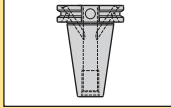

DV40 • DV50

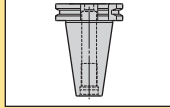

QC30 • QC40 • QC50

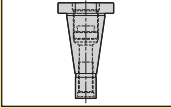

R8

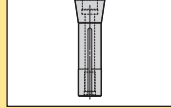

SS

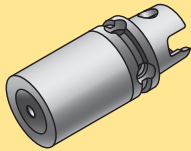
Opzioni portautensili ERICKSON
Accessori

Semilavorati

	HSK40A	Pagina: C21	HSK40E	Pagina: C153	BT50	Pagina: E95
	HSK50A	Pagina: C31	HSK50E		CV40	Pagina: F39
	HSK63T	Pagina: C40	HSK63F		CV50	Pagina: F83
	HSK63A	Pagina: C73	HSK80F		DV40	Pagina: G41
	HSK80A	Pagina: C90	BTKV40	Pagina: D19	DV50	Pagina: G77
	HSK100A	Pagina: C121	BTKV50	Pagina: D37	QC30	
	HSK32C	Pagina: C125	CVKV40	Pagina: D51	QC40	
	HSK40C	Pagina: C133	CVKV50	Pagina: D67	QC50	
	HSK50C	Pagina: C139	BT30		R8	
	HSK63C	Pagina: C145	BT40	Pagina: E60	Codoli dritti	

Tappi

	HSK40A		HSK40E		BT50	
	HSK50A		HSK50E		CV40	
	HSK63T		HSK63F		CV50	
	HSK63A	Pagina: L54	HSK80F		DV40	
	HSK80A		BTKV40		DV50	
	HSK100A	Pagina: L54	BTKV50		QC30	
	HSK32C		CVKV40		QC40	
	HSK40C		CVKV50		QC50	
	HSK50C		BT30		R8	
	HSK63C		BT40		Codoli dritti	

Barre campione

	HSK40A		HSK40E		BT50	
	HSK50A		HSK50E		CV40	
	HSK63T		HSK63F		CV50	
	HSK63A	Pagina: C73	HSK80F		DV40	
	HSK80A		BTKV40		DV50	
	HSK100A	Pagina: C121	BTKV50		QC30	
	HSK32C		CVKV40		QC40	
	HSK40C		CVKV50		QC50	
	HSK50C		BT30		R8	
	HSK63C		BT40		Codoli dritti	

Indica "non disponibile".

Opzioni portautensili ERICKSON

HSK40A • HSK50A • HSK63T
HSK63A • HSK80A • HSK100A

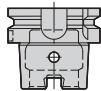

HSK32C • HSK40C
HSK50C • HSK63C



HSK40E • HSK50E



HSK63FP • HSK80FP



BTKV40 • BTKV50

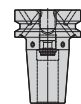

CVKV40 • CVKV50

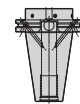

Accessori

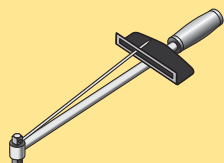

Unità refrigerante

	HSK40A	Pagina: L56	HSK40E	Pagina: L56	BT50	
	HSK50A	Pagina: L56	HSK50E	Pagina: L56	CV40	
	HSK63T	Pagina: L56	HSK63F	Pagina: L56	CV50	
	HSK63A	Pagina: L56	HSK80F	Pagina: L56	DV40	
	HSK80A	Pagina: L56	BTKV40		DV50	
	HSK100A	Pagina: L56	BTKV50		QC30	
	HSK32C		CVKV40		QC40	
	HSK40C		CVKV50		QC50	
	HSK50C		BT30		R8	
	HSK63C		BT40		Codoli dritti	

Codoli di ritenuta

	HSK40A		HSK40E		BT50	Pagine: L57-L62
	HSK50A		HSK50E		CV40	Pagine: L57-L62
	HSK63T		HSK63F		CV50	Pagine: L57-L62
	HSK63A		HSK80F		DV40	Pagine: L57-L62
	HSK80A		BTKV40		DV50	Pagine: L57-L62
	HSK100A		BTKV50		QC30	
	HSK32C		CVKV40		QC40	
	HSK40C		CVKV50		QC50	
	HSK50C		BT30		R8	
	HSK63C		BT40		Codoli dritti	

Foratura

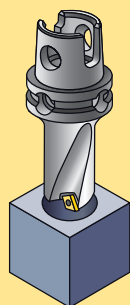

Calettamento a caldo

	HSK40A	Pagine: C8-C11	HSK40E	Pagine: C147-C149	BT50	Pagine: E66-E69
	HSK50A	Pagine: C24-C25	HSK50E	Pagina: C155	CV40	Pagine: F6-F9
	HSK63T		HSK63F	Pagina: C159	CV50	Pagine: F44-F47
	HSK63A	Pagine: C46-C50	HSK80F	Pagina: C163	DV40	Pagine: G6-G9
	HSK80A	Pagine: C76-C79	BTKV40	Pagine: D4-D7	DV50	Pagine: G46-G49
	HSK100A	Pagine: C96-C99	BTKV50	Pagine: D22-D25	QC30	
	HSK32C		CVKV40	Pagine: D40-D43	QC40	
	HSK40C		CVKV50	Pagine: D54-D57	QC50	
	HSK50C		BT30	Pagine: E4-E6	R8	
	HSK63C		BT40	Pagine: E24-E27	Codoli dritti	

Mandrini idraulici Slim Line

	HSK40A	Pagine: C12-C13	HSK40E		BT50	Pagine: E70-E71
	HSK50A		HSK50E		CV40	Pagine: F10-F11
	HSK63T		HSK63F		CV50	Pagine: F48-F49
	HSK63A	Pagine: C52-C53	HSK80F		DV40	Pagine: G10-G11
	HSK80A		BTKV40		DV50	Pagine: G50-G51
	HSK100A	Pagine: C100-C101	BTKV50		QC30	
	HSK32C		CVKV40		QC40	
	HSK40C	Pagine: C128-C129	CVKV50		QC50	
	HSK50C		BT30		R8	
	HSK63C		BT40		Pagine: E28-E29	

Indica "non disponibile".

(continua)

BT30 • BT40 • BT50	CV40 • CV50	DV40 • DV50	QC30 • QC40 • QC50	R8	SS	Opzioni portautensili ERICKSON

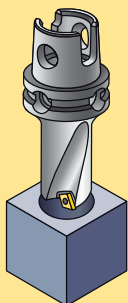
Foratura (continua)

Mandrini idraulici

	HSK40A	Pagine: C12–C15	HSK40E	Pagina: C150	BT50	Pagine: E70–E74
	HSK50A	Pagina: C26	HSK50E	Pagina: C156	CV40	Pagine: F10–F16
	HSK63T		HSK63F		CV50	Pagine: F48–F54
	HSK63A	Pagine: C52–C55	HSK80F		DV40	Pagine: G10–G14
	HSK80A	Pagine: C80–C81	BTKV40		DV50	Pagine: F50–F53
	HSK100A	Pagine: C100–C103	BTKV50		QC30	
	HSK32C	Pagina: C124	CVKV40		QC40	
	HSK40C	Pagine: C128–C130	CVKV50		QC50	
	HSK50C	Pagine: C136–C137	BT30		Pagina: E7	
	HSK63C	Pagine: C141–C142	BT40		Pagine: E28–E32	Codoli dritti

Mandrini a forte serraggio

	HSK40A		HSK40E		BT50	Pagina: E75
	HSK50A		HSK50E		CV40	Pagina: F17
	HSK63T		HSK63F		CV50	Pagina: F55
	HSK63A	Pagina: C56	HSK80F		DV40	Pagina: G15
	HSK80A		BTKV40		DV50	Pagina: G54
	HSK100A	Pagina: C104	BTKV50		QC30	
	HSK32C		CVKV40		QC40	
	HSK40C		CVKV50		QC50	
	HSK50C		BT30		Pagina: E8	
	HSK63C		BT40		Pagina: E33	Codoli dritti

Mandrini portapinza TG

	HSK40A	Pagina: C16	HSK40E		BT50	Pagina: E76	
	HSK50A	Pagina: C27	HSK50E		CV40	Pagine: F18–F20	
	HSK63T		HSK63F		CV50	Pagine: F56–F60	
	HSK63A	Pagina: C57	HSK80F		DV40	Pagine: G16–G17	
	HSK80A	Pagina: C82	BTKV40		DV50	Pagine: G55–G56	
	HSK100A	Pagina: C105	BTKV50		Pagina: D3	QC30	Pagina: H4
	HSK32C		CVKV40		Pagina: D45	QC40	Pagina: H11
	HSK40C		CVKV50		Pagina: D58	QC50	Pagina: H19
	HSK50C		BT30		Pagina: E9	R8	
	HSK63C		BT40		Pagina: E34	Codoli dritti	Pagine: I6–I7

Mandrini portapinza ER

	HSK40A	Pagina: C17	HSK40E	Pagina: C151	BT50	Pagine: E77–E79
	HSK50A	Pagine: C28–C29	HSK50E		CV40	Pagine: F21–F23
	HSK63T		HSK63F	Pagina: C160	CV50	Pagine: F61–F63
	HSK63A	Pagine: C58–C59	HSK80F	Pagina: C164	DV40	Pagine: G18–G21
	HSK80A	Pagine: C83–C84	BTKV40	Pagine: D10–D11	DV50	Pagine: G57–G59
	HSK100A	Pagine: C106–C107	BTKV50	Pagine: D28–D29	QC30	
	HSK32C	Pagina: C125	CVKV40	Pagine: D46–D47	QC40	
	HSK40C	Pagina: C131	CVKV50	Pagine: D60–D61	QC50	
	HSK50C	Pagina: C138	BT30	Pagine: E10–E11	R8	
	HSK63C	Pagina: C143	BT40	Pagine: E35–E37	Codoli dritti	Pagine: I8–I11

Indica "non disponibile".

(continua)

Opzioni portautensili ERICKSON

HSK40A • HSK50A • HSK63T
HSK63A • HSK80A • HSK100A

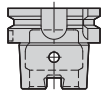

HSK32C • HSK40C
HSK50C • HSK63C



HSK40E • HSK50E



HSK63FP • HSK80FP



BTKV40 • BTKV50

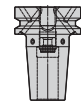

CVKV40 • CVKV50

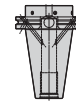

Foratura (continua)

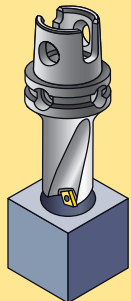

Mandrini portapinzza DA

	HSK40A		HSK40E		BT50	Pagina: E80
	HSK50A		HSK50E		CV40	Pagina: F24
	HSK63T		HSK63F		CV50	Pagina: F64
	HSK63A		HSK80F		DV40	Pagine: G22–G25
	HSK80A		BTKV40		DV50	Pagine: G60–G61
	HSK100A		BTKV50		QC30	Pagina: H5
	HSK32C		CVKV40		QC40	Pagina: H12
	HSK40C		CVKV50		QC50	
	HSK50C		BT30		R8	Pagina: H26
	HSK63C		BT40		Codoli dritti	Pagina: I12–I22
					Pagine: E12–E13	
					Pagine: E38–E39	

Mandrini portapunta

	HSK40A		HSK40E		BT50	Pagina: E80	
	HSK50A		HSK50E		CV40	Pagina: F25	
	HSK63T		HSK63F		CV50	Pagina: F65	
	HSK63A		Pagina: C60		HSK80F	DV40	Pagina: G26
	HSK80A				BTKV40	DV50	Pagina: G62
	HSK100A		Pagina: C108		BTKV50	QC30	
	HSK32C				CVKV40	QC40	
	HSK40C				CVKV50	QC50	
	HSK50C				BT30	R8	
	HSK63C				BT40	Codoli dritti	
						Pagina: E14	
					Pagina: E40		

Adattatori Whistle Notch™

	HSK40A	Pagina: C18	HSK40E		BT50	Pagina: E81–E82	
	HSK50A		HSK50E		CV40	Pagina: F26–F27	
	HSK63T		HSK63F		CV50	Pagina: F66–F68	
	HSK63A		Pagine: C60–C61		HSK80F	DV40	Pagina: G27–G28
	HSK80A		Pagina: C85		BTKV40	DV50	Pagina: G63–G64
	HSK100A		Pagine: C108–C109		BTKV50	QC30	
	HSK32C				CVKV40	QC40	
	HSK40C		Pagina: C132		CVKV50	QC50	
	HSK50C		Pagina: C139		BT30	R8	
	HSK63C		Pagina: C144		BT40	Codoli dritti	
						Pagina: E14	
						Pagine: E41–E42	

Codoli dritti

	HSK40A		HSK40E		BT50		
	HSK50A		HSK50E		CV40	Pagina: F30	
	HSK63T		HSK63F		CV50	Pagina: F73–F74	
	HSK63A		Pagina: C63		HSK80F	DV40	
	HSK80A				BTKV40	DV50	
	HSK100A				BTKV50	QC30	
	HSK32C				CVKV40	QC40	
	HSK40C				CVKV50	QC50	
	HSK50C				BT30	R8	
	HSK63C		BT40		Codoli dritti		
						Pagina: E46	

Indica "non disponibile".

(continua)

BT30 • BT40 • BT50

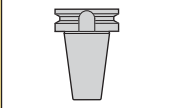

CV40 • CV50

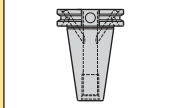

DV40 • DV50

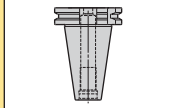

QC30 • QC40 • QC50

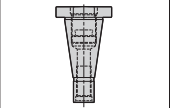

R8

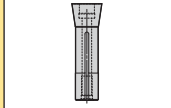

SS

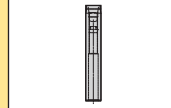
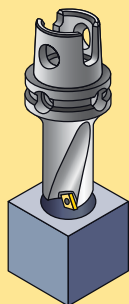
Opzioni portautensili ERICKSON
Foratura (continua)

Coni Morse

	HSK40A		HSK40E		BT50	Pagina: E92	
	HSK50A		HSK50E		CV40	Pagina: F36	
	HSK63T		HSK63F		CV50	Pagina: F80	
	HSK63A	Pagina: C70	HSK80F		DV40	Pagina: G37	
	HSK80A		BTKV40		DV50	Pagina: G73	
	HSK100A	Pagina: C118	BTKV50		QC30	Pagina: H8	
	HSK32C		CVKV40		QC40	Pagina: H16	
	HSK40C		CVKV50		QC50	Pagina: H22	
	HSK50C		BT30		R8		
	HSK63C		BT40		Codoli dritti		
					Pagina: E57		

Jacobs/DIN

	HSK40A		HSK40E		BT50	Pagina: E92		
	HSK50A		HSK50E		CV40	Pagina: F37		
	HSK63T		HSK63F		CV50	Pagina: F81		
	HSK63A		HSK80F		DV40			
	HSK80A		BTKV40		DV50			
	HSK100A		BTKV50		QC30	Pagina: H9		
	HSK32C		CVKV40		QC40	Pagina: H17		
	HSK40C		CVKV50		QC50			
	HSK50C		BT30		R8			
	HSK63C		BT40		Codoli dritti			
					Pagina: E57			

Indica "non disponibile".

Opzioni portautensili ERICKSON

HSK40A • HSK50A • HSK63T
HSK63A • HSK80A • HSK100A

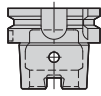

HSK32C • HSK40C
HSK50C • HSK63C



HSK40E • HSK50E



HSK63FP • HSK80FP



BTKV40 • BTKV50

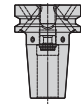

CVKV40 • CVKV50

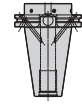

Pinze e riduzioni

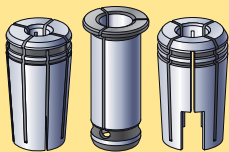

Riduzioni per forte serraggio

Pagine: J6–J9

Riduzioni per idraulici

Pagine: J2–J5

Pinze TG

Pagine: J14–J19, J22–J27, J30–J38, J42–J47

Pinze ER

Pagine: J54–J57

Pinze DA

Pagine: J65–J69

Maschiatura

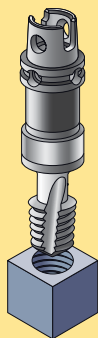

Cambio rapido RC • Trazione e compressione

	HSK40A		HSK40E		BT50	Pagina: E91
	HSK50A		HSK50E		CV40	Pagina: F35
	HSK63T	Pagina: C70	HSK63F		CV50	Pagina: F79
	HSK63A		HSK80F		DV40	Pagina: G36
	HSK80A	Pagina: C118	BTKV40		DV50	Pagina: G72
	HSK100A		BTKV50		QC30	
	HSK32C		CVKV40		QC40	
	HSK40C		CVKV50		QC50	
	HSK50C		BT30		R8	
	HSK63C		BT40		Codoli dritti	
	Pagina: E56					

Cambio rapido RC • Fisso

	HSK40A		HSK40E		BT50	Pagina: E91
	HSK50A		HSK50E		CV40	Pagina: F36
	HSK63T		HSK63F		CV50	Pagina: F80
	HSK63A		HSK80F		DV40	Pagina: G36
	HSK80A		BTKV40		DV50	Pagina: G73
	HSK100A		BTKV50		QC30	
	HSK32C		CVKV40		QC40	
	HSK40C		CVKV50		QC50	
	HSK50C		BT30		R8	
	HSK63C		BT40		Codoli dritti	
	Pagina: E56					

Indica "non disponibile".

(continua)

BT30 • BT40 • BT50



CV40 • CV50

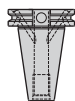

DV40 • DV50

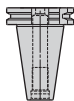

QC30 • QC40 • QC50

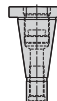

R8

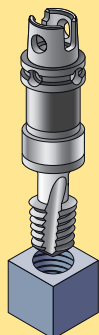

SS

Opzioni portautensili ERICKSON
Maschiatura (continua)

Mandri portapinza TG

	HSK40A	Pagina: C16	HSK40E		BT50	Pagina: E76
	HSK50A	Pagina: C27	HSK50E		CV40	Pagine: F18-F20
	HSK63T		HSK63F		CV50	Pagine: F56-F60
	HSK63A	Pagina: C57	HSK80F		DV40	Pagine: G16-G17
	HSK80A	Pagina: C82	BTKV40		DV50	Pagine: G55-G56
	HSK100A	Pagina: C105	BTKV50		QC30	Pagina: H4
	HSK32C		CVKV40		QC40	Pagina: H11
	HSK40C		CVKV50		QC50	Pagina: H19
	HSK50C		BT30		R8	
	HSK63C		BT40		Pagina: E34	Codoli dritti

Mandri portapinza ER

	HSK40A	Pagina: C17	HSK40E	Pagina: C151	BT50	Pagine: E77-E79
	HSK50A	Pagine: C28-C29	HSK50E		CV40	Pagine: F21-F23
	HSK63T		HSK63F	Pagina: C160	CV50	Pagine: F61-F63
	HSK63A	Pagine: C58-C59	HSK80F	Pagina: C164	DV40	Pagine: G18-G21
	HSK80A	Pagine: C83-C84	BTKV40	Pagine: D10-D11	DV50	Pagine: G57-G59
	HSK100A	Pagine: C106-C107	BTKV50	Pagine: D28-D29	QC30	
	HSK32C	Pagina: C125	CVKV40	Pagine: D46-D47	QC40	
	HSK40C	Pagina: C131	CVKV50	Pagine: D60-D61	QC50	
	HSK50C	Pagina: C138	BT30	Pagine: E10-E11	R8	
	HSK63C	Pagina: C143	BT40	Pagine: E35-E37	Codoli dritti	Pagine: I8-I11

Mandri portapinza DA

	HSK40A		HSK40E		BT50	Pagina: E80	
	HSK50A		HSK50E		CV40	Pagina: F24	
	HSK63T		HSK63F		CV50	Pagina: F64	
	HSK63A		HSK80F		DV40	Pagine: G22-G25	
	HSK80A		BTKV40		DV50	Pagine: G60-G61	
	HSK100A		BTKV50		QC30	Pagina: H5	
	HSK32C		CVKV40		QC40	Pagina: H12	
	HSK40C		CVKV50		QC50		
	HSK50C		BT30		Pagine: E12-E13	R8	Pagina: H26
	HSK63C		BT40		Pagine: E38-E39	Codoli dritti	Pagine: I12-I22

Adattatori TA

	HSK40A		HSK40E		BT50	Pagina: E82
	HSK50A		HSK50E		CV40	Pagina: F27
	HSK63T		HSK63F		CV50	
	HSK63A		HSK80F		DV40	
	HSK80A		BTKV40		DV50	
	HSK100A		BTKV50		QC30	
	HSK32C		CVKV40		QC40	
	HSK40C		CVKV50		QC50	
	HSK50C		BT30		R8	
	HSK63C		BT40		Pagina: E42	

Indica "non disponibile".

Opzioni portautensili ERICKSON

HSK40A • HSK50A • HSK63T
HSK63A • HSK80A • HSK100A

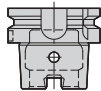

HSK32C • HSK40C
HSK50C • HSK63C



HSK40E • HSK50E



HSK63FP • HSK80FP



BTKV40 • BTKV50

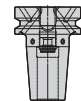

CVKV40 • CVKV50

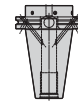

Pinze e adattatori

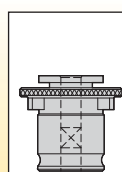
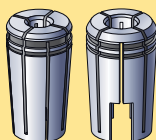

Adattatori cambio rapido RC

Pagine: J76–J81

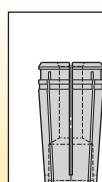

Pinze TG

Pagine: J20–J21, J28–J29, J40–J41, J48

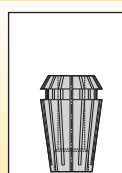

Pinze ER

Pagine: J58–J60

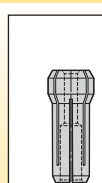

Pinze DA

Pagine: J71–J75

Barenatura

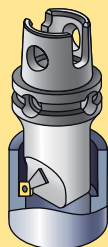

Indica "non disponibile".

Romicron™

	HSK40A		HSK40E		BT50	Pagina: E93
	HSK50A		HSK50E		CV40	Pagina: F37
	HSK63T		HSK63F		CV50	Pagina: F81
	HSK63A	Pagina: C71	HSK80F		DV40	Pagina: G38
	HSK80A		BTKV40		DV50	Pagina: G74
	HSK100A	Pagina: C119	BTKV50		QC30	
	HSK32C		CVKV40	QC40		
	HSK40C		CVKV50	QC50		
	HSK50C		BT30	R8		
	HSK63C		BT40	Codoli dritti		
				Pagina: E58		

BT30 • BT40 • BT50

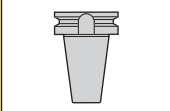

CV40 • CV50

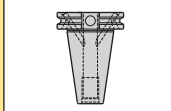

DV40 • DV50

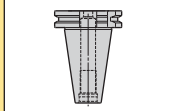

QC30 • QC40 • QC50

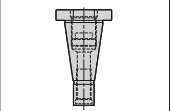

R8

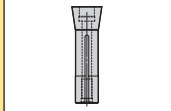

SS

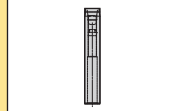
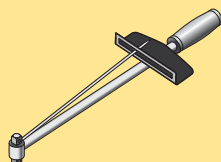
Opzioni portautensili ERICKSON
Accessori

Unità refrigerante

	HSK40A	Pagina: L44	HSK40E	Pagina: L44	BT50	
	HSK50A	Pagina: L44	HSK50E	Pagina: L44	CV40	
	HSK63T	Pagina: L44	HSK63F	Pagina: L44	CV50	
	HSK63A	Pagina: L44	HSK80F	Pagina: L44	DV40	
	HSK80A	Pagina: L44	BTKV40		DV50	
	HSK100A	Pagina: L44	BTKV50		QC30	
	HSK32C		CVKV40		QC40	
	HSK40C		CVKV50		QC50	
	HSK50C		BT30		R8	
	HSK63C		BT40	Codoli dritti		

Codoli di ritenuta

	HSK40A		HSK40E		BT50	Pagine: L46–L50
	HSK50A		HSK50E		CV40	Pagine: L46–L50
	HSK63T		HSK63F		CV50	Pagine: L46–L50
	HSK63A		HSK80F		DV40	Pagine: L46–L50
	HSK80A		BTKV40	Pagina: L46–L50	DV50	Pagine: L46–L50
	HSK100A		BTKV50	Pagina: L46–L50	QC30	
	HSK32C		CVKV40	Pagina: L46–L50	QC40	
	HSK40C		CVKV50	Pagina: L46–L50	QC50	
	HSK50C		BT30	Pagina: L46–L50	R8	
	HSK63C		BT40	Pagina: L46–L50	Codoli dritti	

Indica "non disponibile".